

Capacidad 26 Tm (-SK) H = 1450 mm Ch = 1050 mm

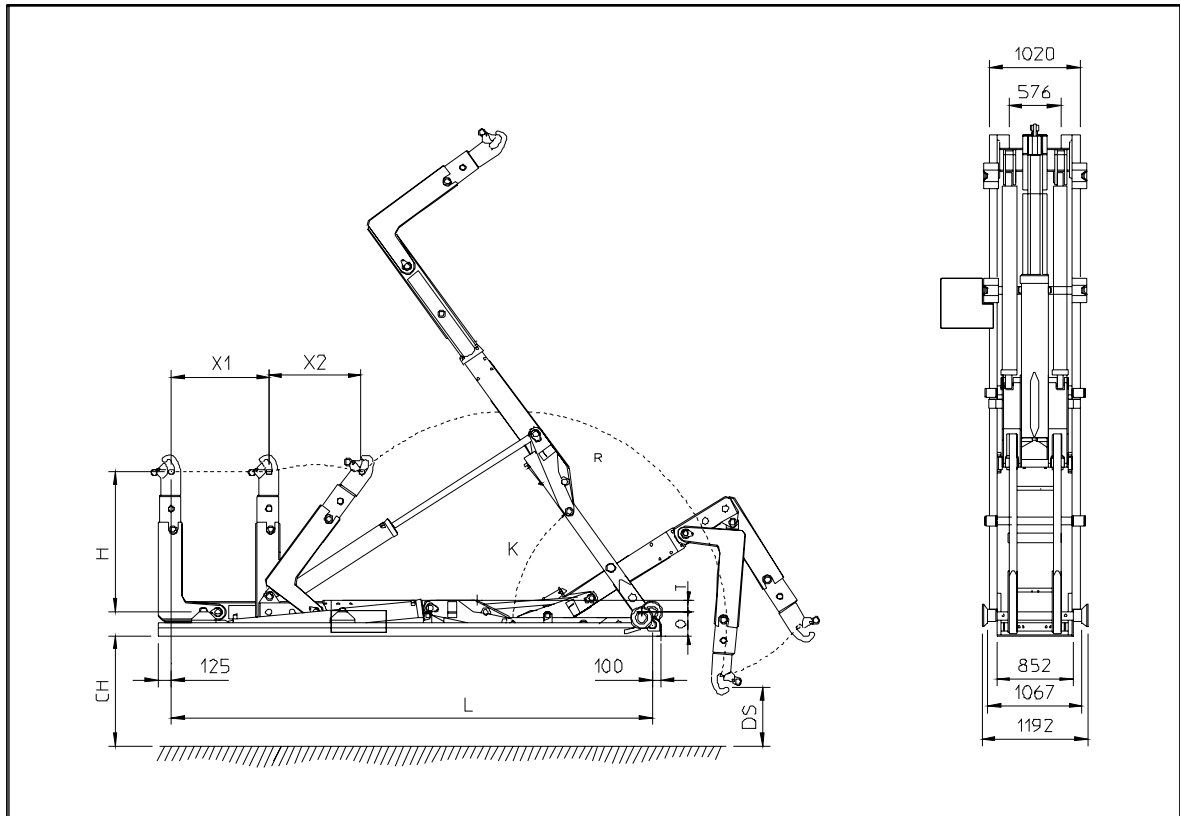

MODELO	X (mm)	L (mm)	O (mm)	K	R (mm)	T (mm)	PESO (kg)	MS (mm)	LONGITUD MIN./MAX DEL CONTENEDOR (mm)
26-49-SK	800 + 1050	4900	280	57°	2310	130	2850	665	3050-6000
26-53-SK	1000 + 1050	5350	280	53°	2345	130	2925	667	3300-6450
26-55-SK	1000 + 1050	5550	280	54°	2495	130	2975	790	3300-6650
26-57-SK	1200 + 1050	5700	280	54°	2455	130	3075	761	3450-6800
26-58-SK	1300 + 1050	5800	280	56°	2455	130	3075	681	3650-6900
26-60-SK	1300 + 1050	6000	280	53°	2495	130	3125	708	3650-7100
26-62-SK	1300 + 1050	6200	280	50°	2495	130	3175	708	3850-7300
26-65-SK	1300 + 1050	6500	280	51°	2720	130	3225	789	4150-7600

H = Hookheight
 CH = Chassisheight
 MS = *Medida mínima desde el suelo