

EQUIPO DE GANCHO 10 Tm.

GANCHO; 1570 mm, CHASIS: 1.050 mm

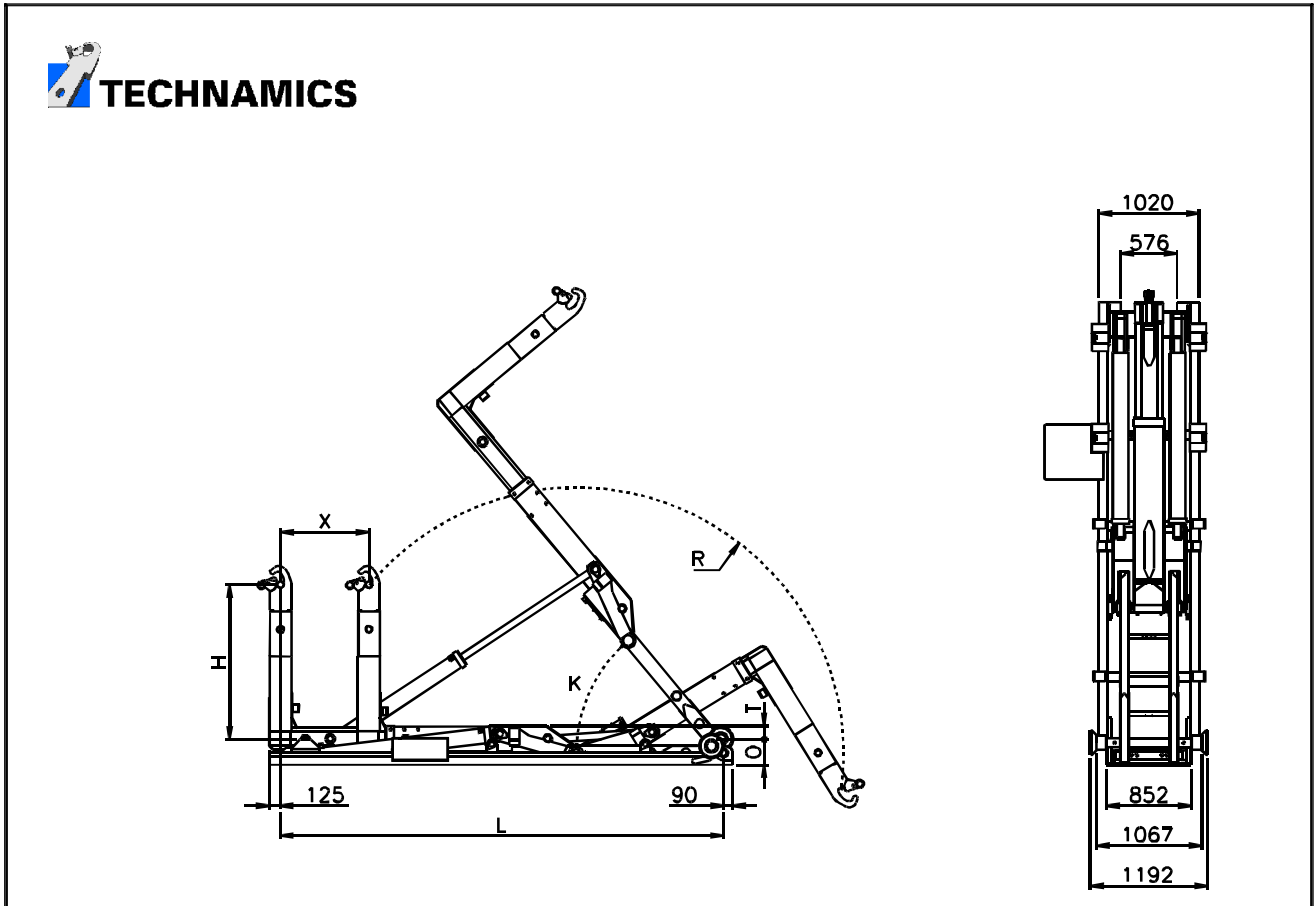

TIPO	X (mm)	L (mm)	O (mm)	K	R (mm)	T (mm)	PESO (kg)	LARGO CONTENEDOR (mm)
10-39-S	800	3900	260	52°	2565	130	1750	3150-5000
10-42-S	900	4200	260	50°	2640	130	1800	3350-5300
10-45-S	900	4500	260	50°	2715	130	1850	3650-5600
10-47-S	1000	4700	260	50°	2795	130	1930	3750-5800
10-49-S	1000	4900	260	48°	2875	130	1980	3900-6000
10-51-S	1000	5100	260	50°	3045	130	2050	4150-6200
10-53-S	1000	5350	260	50°	3035	130	2080	4350-6450
10-55-S	1200	5550	260	50°	3035	130	2100	4350-6650
10-57-S	1200	5700	260	47°	3035	130	2150	4500-6800